



IMC Thermal Series 2:35MM

Thermal Imaging Bullet Network Camera

IMC2-TH-640-35 AND ACCESSORIES



Key Features

- Uncooled VOx Micro bolometer with 640×512 resolution
- 9/15/25/35/50 mm fixed lens optional
- Sensitivity $\leq 40\text{mK}$
- Support temperature monitoring and alarm
- Support humanoid/vehicle detection, fire point detection
- Intelligent function: intrusion, single line crossing, double line crossing, loitering, wrong-way, enter area, leave area
- Support 3 temperature measurement rule types (spot, line, area)
- Temperature measurement range: $-20^{\circ}\text{C} \sim 150^{\circ}\text{C}$ ($-4^{\circ}\text{F} \sim 302^{\circ}\text{F}$)
- Support DC12V/PoE/AC24V power supply
- IP66

Specification

Thermal Camera					
Image Sensor	Uncooled VOx Micro bolometer 640x512				
Resolution	Sensor is 640x512. Image can be scaled up to 1280x1024				
Pixel Pitch	12µm				
Spectral Range	8-14µm				
Thermal Sensitivity (NETD)	≤ 40 mK				
Lens Type	Fixed focal length				
Focus Control	Free focus				
Focal Length	9 mm	15 mm	25 mm	35 mm	50 mm
F No.	F1.0	F1.0	F1.0	F1.0	F1.0
Angle of View	H: 48°, V:38°	H:32°, V:26°	H:17°, V:14°	H: 12°, V:10°	H: 8°, V:7°
Min. Focusing Distance	1.73 m	3.79 m	13 m	25.49 m	52.3 m
Detection Distance (Fire: 1m×1m)	375 m	625 m	1042 m	1458 m	2083 m
Detection Distance (Humans: 1.8x0.5m)	375 m	624 m	1040 m	1456 m	2081 m
Detection Distance (Vehicles: 4x1.5m)	1150 m	1917 m	3194 m	4472 m	6389 m
Recognition Distance (Humans: 1.8x0.5m)	94 m	156 m	260 m	364 m	520 m
Recognition Distance (Vehicles 4x1.5m)	288 m	479 m	799 m	1118 m	1597 m
Video and Audio					
Main Stream	1280x1024, 1280x720, 640x512 @ 25fps				
Sub Stream	D1, CIF @ 25fps				
Bit Rate Control	CBR/VBR				
Bit Rate	Main stream: 100Kbps ~ 8Mbps Sub stream: 100Kbps ~ 6Mbps				
Region of Interest	Off / On (8 Zone, Rectangle)				
Smart Encode	Support				
Audio Compression	G.711: 8kbps, RAW_PCM: 16kbps				
Image					
Image Setting	Brightness, Sharpness, Contrast				
Mirror	Support				
Pseudo-color Setting	White-hot/Black-hot/Rainbow/Ironbow etc. up to 17 modes				
DVE Image Enhance	Support				
Noise Reduction	2D/3D DNR				
Privacy Masking	Support				
Smart Function					
Smart Alarm	Motion detection, I/O alarm, Disk alarm, IVS alarm, Temperature detection & alarm				
Smart Detection	Support human/vehicle detection, fire point detection				
Smart Events	Intrusion, Single line crossing, Double line crossing, Loitering, Wrong-way, Enter area, Leave area Support alarm triggering by specified target types (human and vehicle)				

Temperature Detection	
Temperature Detection	3 temperature measurement rule types, 20 rules in total, 1 full screen, 19 others (spot, areas, line).
Temperature Alarm	Over temperature alarm, Temperature difference alarm
Accuracy	±2°C / ±2%
Response Time	≤ 30ms
Temperature Range	-20°C ~ 150°C (-4°F ~ 302°F)
Network	
Protocols	IPv4/IPv6, HTTP, RTSP/RTP/RTCP, TCP/UDP, DHCP, DNS, PPPOE, SMTP, 802.1x
Interoperability	ONVIF, SDK
Web Viewer	<IE11, Chrome, Firefox, Microsoft Edge
Web Language	English, Chinese, Polish, Italian, Portuguese, Spanish, Russian, French, Czech, Hungarian
Interface	
Network Interface	1 Ethernet (10/100 Base-T) RJ-45 Connector
Audio Interface	1ch input, 1ch output
Alarm Interface	2ch input, 2ch output
Control Interface	1ch RS485
CVBS Interface	BNC, 75 ohm
Reset Button	Support
SD Card Slot	Built-in, up to 256GB
General	
Power Supply	DC12V/PoE/AC24V
Power Consumption	Max 5 W
Working Temperature	-40°C ~ 60°C (-40°F ~ 140°F)
Storage Conditions	0~ 90% RH
Certifications	CE/FCC
Ingress Protection	IP66
Casing	Metal
Dimensions	φ120.5 × 315.9 ~ 352.6 mm (φ4.74 × 12.44 ~ 13.88 inch)
Net Weight	1.85 kg (4.08 lb) with 9mm lens

Dimensions (mm)

With 9/15mm Lens

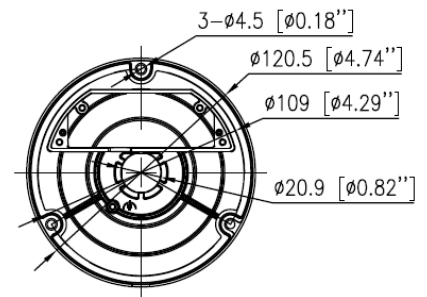
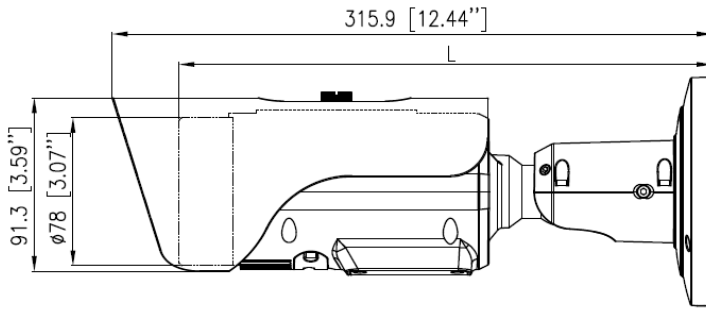

Accessories

Optional:



IMCA-JB-007
Junction Box



IMCA-PM-005
Pole Mount



IMCA-CM-02
Corner Mount