



IMC Thermal Series 2 35MM

Thermal Network Bullet Camera

IMC2-TH-400-35 AND ACCESSORIES



Key Features

- Uncooled VOx Micro bolometer with 400×300 resolution
- 8/15/25/35/50 mm fixed lens optional
- Sensitivity $\leq 40\text{mK}$
- Support temperature monitoring and exception alarm
- Temperature detection range: $-20\text{ }^{\circ}\text{C}$ to $150\text{ }^{\circ}\text{C}$ ($-4\text{ }^{\circ}\text{F}$ to $302\text{ }^{\circ}\text{F}$)
- Support 3 temperature measurement rule types (spot, line, area)
- Support human and vehicle detection
- Intelligent analysis: intrusion, single line crossing, double line crossing, loitering, wrong-way, people counting, enter area, leave area
- 12V DC/24V AC/PoE power supply
- IP66

Specification

Thermal Camera					
Detector Type	Uncooled VOx Micro bolometer 400x300				
Resolution	Sensor is 400x300. Image can be scaled up to 704x576				
Pixel Pitch	17 um				
Spectral Range	8-14um				
Thermal Sensitivity (NETD)	≤ 40 mK				
Lens Type	Fixed				
Focus Control	Manual Focus				
Focal Length	8 mm	15 mm	25 mm	35 mm	50 mm
F No.	F1.0	F1.0	F1.0	F1.0	F1.0
Angle of View	H: 46°, V:35.3°	H:25.5°, V:19.2°	H:15.4°, V:11.6°	H: 11°, V:9°	H: 7.7°, V:5.8°
Detection Distance (Fire: 1mx1m)	235 m	441 m	735 m	1029 m	1471 m
Detection Distance (Humans: 1.8x0.5m)	235 m	441 m	735 m	1029 m	1471 m
Detection Distance (Vehicles: 4x1.5m)	722 m	1353 m	2255 m	3137 m	4510 m
Recognition Distance (Humans: 1.8x0.5m)	59 m	110 m	184 m	257 m	368 m
Recognition Distance (Vehicles 4x1.5m)	180 m	338 m	564 m	789 m	1127 m
Video and Audio					
Main Stream	704x576 @ 25/30fps				
Sub Stream	CIF @ 25/30fps				
Bit Rate Control	CBR/VBR				
Bit Rate	Main Stream: 100Kbps ~ 6Mbps Sub Stream: 10Kbps ~ 1.5Mbps				
Region of Interest	Off / On (8 Zone, Rectangle)				
Smart Encode	Support				
Audio Compression	G.711: 8kbps, RAW_PCM: 16kbps				
Image					
Image Setting	Brightness, Sharpness, Contrast				
Mirror	Support				
Pseudo-color Setting	White-hot/Black-hot/Rainbow/Ironbow etc. up to 17 modes				
DVE Image Enhance	Support				
Noise Reduction	2D/3D DNR				
Privacy Masking	Support				
Smart Function					
Smart Alarm	Motion detection, Disk alarm, I/O alarm, IVS alarm, Temperature detection & alarm				
AI Multi-object	Support human and vehicle detection				
Intelligent Analysis	Intrusion, Single line crossing, Double line crossing, Loitering, Wrong-way, Enter area, Leave area (these 7 function support accurate detection of people/vehicles), People counting				

Temperature Detection	
Temperature Detection	3 temperature measurement rule types, 20 rules in total, 1 full screen, 19 others (spot, areas, line).
Temperature Alarm	Over temperature alarm, Temperature difference alarm
Accuracy	±2°C / ±2%
Response Time	≤ 30ms
Temperature Range	-20°C ~ 150°C (-4°F ~ 302°F)
Temperature display mode	Temperature target >5°C, Display absolute temperature value, Temperature target ≤5°C, Display relative temperature value (temperature difference DEV = highest value - average)
Network	
Protocols	IPv4/IPv6 ,HTTP,RTSP/RTP/RTCP, TCP/UDP, DHCP, DNS, PPPOE, SMTP, 802.1x
Interoperability	ONVIF, CGI, SDK
Max. User Access	10 Users
Web Viewer	<IE11, Chrome, Firefox, Microsoft Edge
Web Language	English, Chinese, Polish, Italian, Portuguese, Spanish, Russian, French, Czech, Hungarian
Interface	
Network Interface	1 Ethernet (10/100 Base-T) RJ-45 Connector
Audio Interface	1ch input, 1ch output
Alarm Interface	2ch input, 2ch output
RS485	Support
Reset Button	Support
SD Card Slot	Support, up to 128GB
General	
Power Supply	DC12V/AC24V/POE (IEEE 802.3af)
Power Consumption	Max 5 W
Working Temperature	-40°C ~ 60°C (-40°F ~ 140°F)
Storage Conditions	0~ 90% RH
Certifications	CE/FCC
Ingress Protection	IP66
Casing	Metal
Dimensions	φ110 × 388 mm (φ4.33 × 15.28 inch)
Net Weight	1.8 kg (4.97 lb) with 15mm lens

Dimensions (mm)

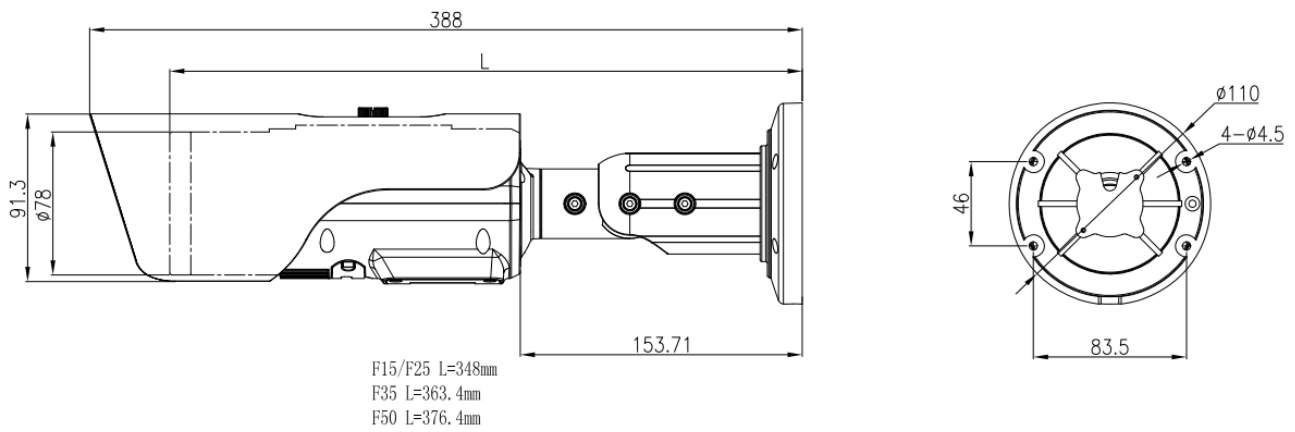

Accessories

Optional:



IMCA-JB-007
Junction Box



IMCA-JB-006
Junction Box



IMCA-PM-005
Pole Mount

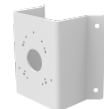

IMCA-CM-02
Corner Mount